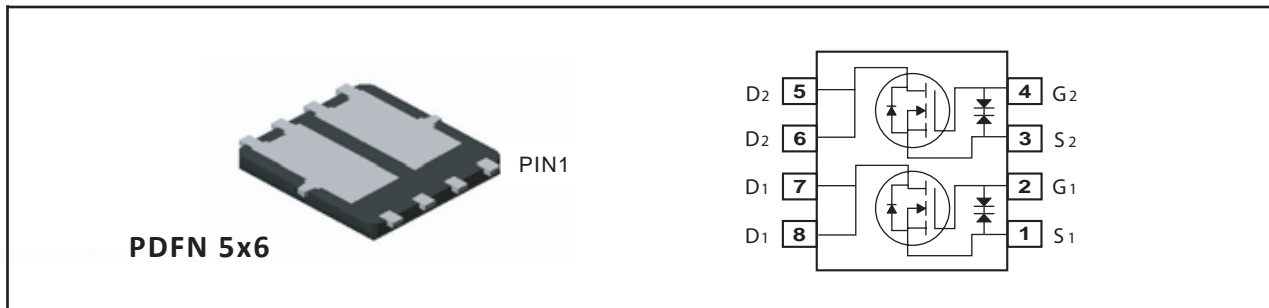

**Dual N-Channel Enhancement Mode Field Effect Transistor**

PRODUCT SUMMARY		
V <sub>DSS</sub>	I <sub>D</sub>	R <sub>DS(ON)</sub> (Ω) Max
100V	1A	2.0 @ V <sub>GS</sub> =10V
		2.4 @ V <sub>GS</sub> =4.5V

**FEATURES**

- Super high dense cell design for low R<sub>DS(ON)</sub>.
- Rugged and reliable.
- Surface Mount Package.
- ESD Protected.

**ABSOLUTE MAXIMUM RATINGS (T<sub>A</sub>=25°C unless otherwise noted)**

Symbol	Parameter	Limit	Units
V <sub>DS</sub>	Drain-Source Voltage	100	V
V <sub>GS</sub>	Gate-Source Voltage	±20	V
I <sub>D</sub>	Drain Current-Continuous <sup>a</sup>	T <sub>A</sub> =25°C	1
		T <sub>A</sub> =70°C	0.8
I <sub>DM</sub>	-Pulsed <sup>b</sup>	4.1	A
E <sub>AS</sub>	Single Pulse Avalanche Energy <sup>d</sup>	0.25	mJ
P <sub>D</sub>	Maximum Power Dissipation <sup>a</sup>	T <sub>A</sub> =25°C	2.5
		T <sub>A</sub> =70°C	1.6
T <sub>J</sub> , T <sub>STG</sub>	Operating Junction and Storage Temperature Range	-55 to 150	°C

**THERMAL CHARACTERISTICS**

R <sub>θJA</sub>	Thermal Resistance, Junction-to-Ambient	50	°C/W
------------------	---	----	------

# SP2106

Ver 1.1

## ELECTRICAL CHARACTERISTICS (T<sub>A</sub>=25°C unless otherwise noted)

Symbol	Parameter	Conditions	Min	Typ	Max	Units
<b>OFF CHARACTERISTICS</b>						
BV <sub>DSS</sub>	Drain-Source Breakdown Voltage	V <sub>GS</sub> =0V, I <sub>D</sub> =10mA	100			V
I <sub>DSS</sub>	Zero Gate Voltage Drain Current	V <sub>DS</sub> =80V, V <sub>GS</sub> =0V			1	uA
I <sub>GSS</sub>	Gate-Body Leakage Current	V <sub>GS</sub> = ±20V, V <sub>DS</sub> =0V			±10	uA
<b>ON CHARACTERISTICS</b>						
V <sub>GS(th)</sub>	Gate Threshold Voltage	V <sub>DS</sub> =V <sub>GS</sub> , I <sub>D</sub> =250uA	1	1.8	3	V
R <sub>DS(ON)</sub>	Drain-Source On-State Resistance	V <sub>GS</sub> =10V, I <sub>D</sub> =0.5A		1.6	2.0	ohm
		V <sub>GS</sub> =4.5V, I <sub>D</sub> =0.5A		1.9	2.4	ohm
g <sub>FS</sub>	Forward Transconductance	V <sub>DS</sub> =10V, I <sub>D</sub> =0.5A		1		S
<b>DYNAMIC CHARACTERISTICS <sup>c</sup></b>						
C <sub>ISS</sub>	Input Capacitance	V <sub>DS</sub> =25V, V <sub>GS</sub> =0V f=1.0MHz		64		pF
C <sub>OSS</sub>	Output Capacitance			14		pF
C <sub>RSS</sub>	Reverse Transfer Capacitance			7		pF
<b>SWITCHING CHARACTERISTICS <sup>c</sup></b>						
t <sub>D(ON)</sub>	Turn-On Delay Time	V <sub>DD</sub> =50V I <sub>D</sub> =0.5A V <sub>GS</sub> =10V R <sub>GEN</sub> = 6 ohm		7.6		ns
t <sub>r</sub>	Rise Time			7.2		ns
t <sub>D(OFF)</sub>	Turn-Off Delay Time			54		ns
t <sub>f</sub>	Fall Time			16		ns
Q <sub>g</sub>	Total Gate Charge	V <sub>DS</sub> =50V, I <sub>D</sub> =0.5A, V <sub>GS</sub> =10V		2		nC
		V <sub>DS</sub> =50V, I <sub>D</sub> =0.5A, V <sub>GS</sub> =4.5V		1.4		nC
Q <sub>gs</sub>	Gate-Source Charge	V <sub>DS</sub> =50V, I <sub>D</sub> =0.5A, V <sub>GS</sub> =10V		0.5		nC
Q <sub>gd</sub>	Gate-Drain Charge			0.7		nC
<b>DRAIN-SOURCE DIODE CHARACTERISTICS AND MAXIMUM RATINGS</b>						
V <sub>SD</sub>	Diode Forward Voltage	V <sub>GS</sub> =0V, I <sub>S</sub> =0.5A		0.86	1.2	V

### Notes

- Surface Mounted on FR4 Board, t ≤ 10sec.
- Pulse Test: Pulse Width < 10us, Duty Cycle < 1%.
- Guaranteed by design, not subject to production testing.
- Starting T<sub>J</sub>=25°C, L=0.5mH, V<sub>DD</sub> = 50V. (See Figure13)

Jul,18,2013

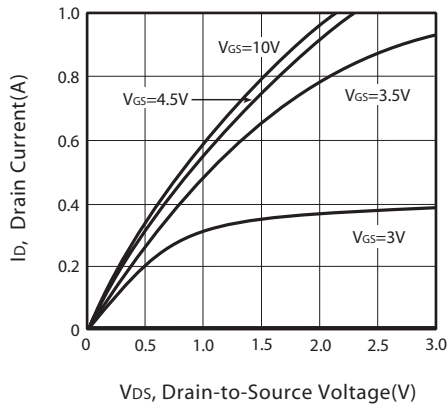

Figure 1. Output Characteristics

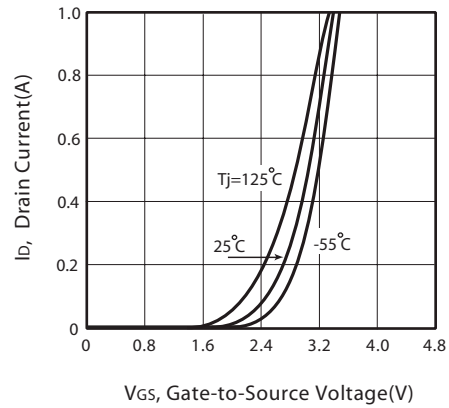

Figure 2. Transfer Characteristics

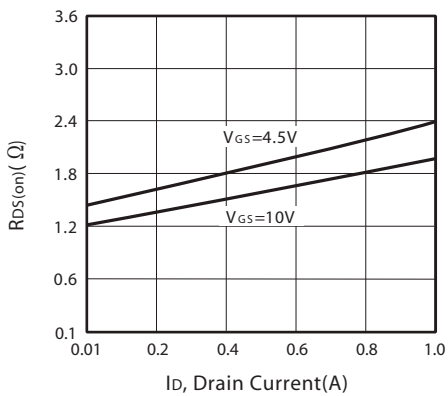

Figure 3. On-Resistance vs. Drain Current and Gate Voltage

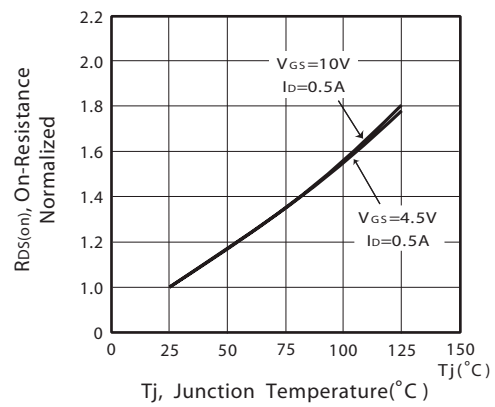

Figure 4. On-Resistance Variation with Drain Current and Temperature

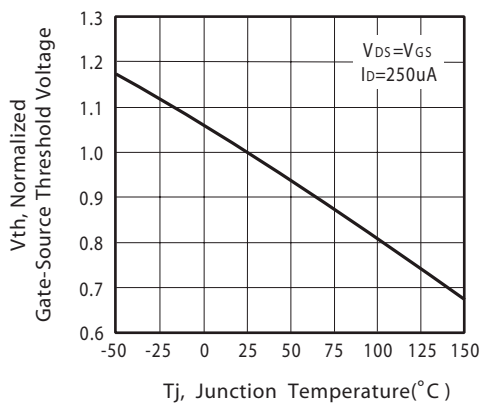

Figure 5. Gate Threshold Variation with Temperature

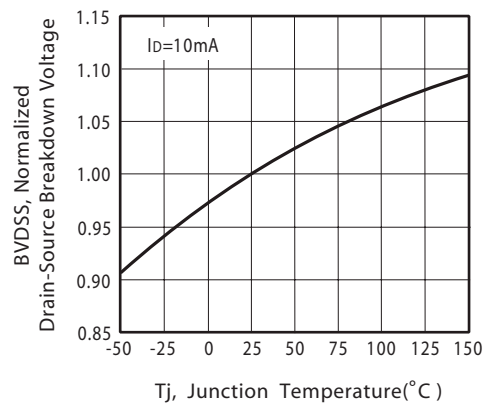

Figure 6. Breakdown Voltage Variation with Temperature

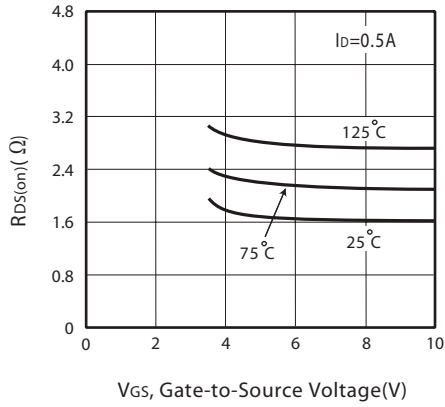

Figure 7. On-Resistance vs. Gate-Source Voltage

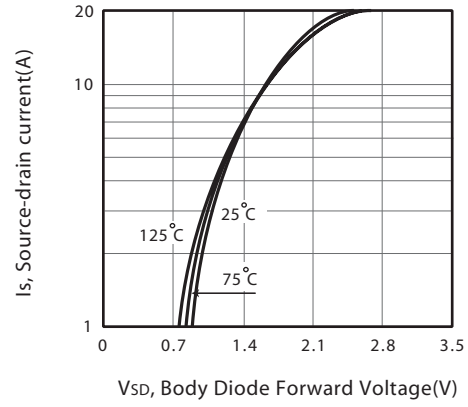

Figure 8. Body Diode Forward Voltage Variation with Source Current

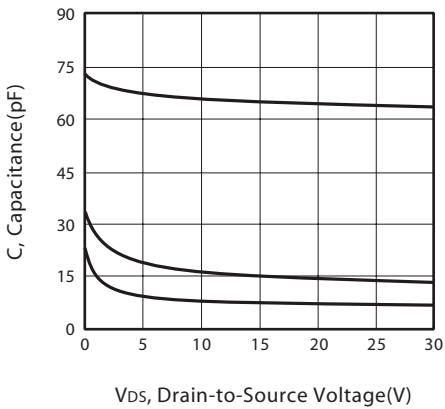

Figure 9. Capacitance

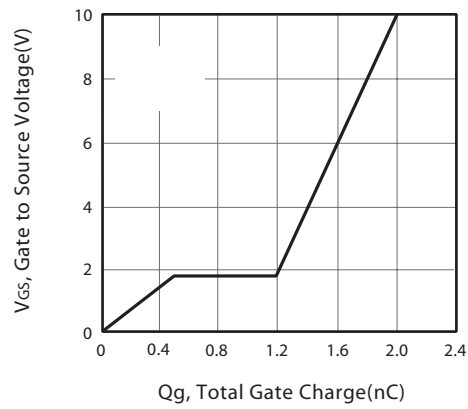

Figure 10. Gate Charge

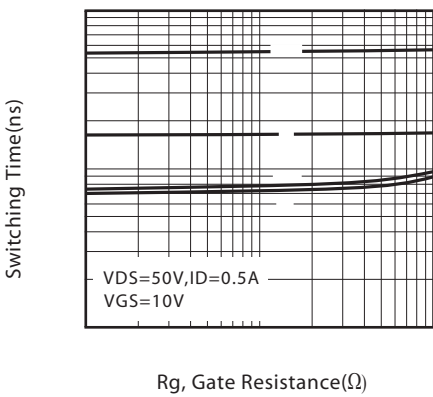

Figure 11. switching characteristics

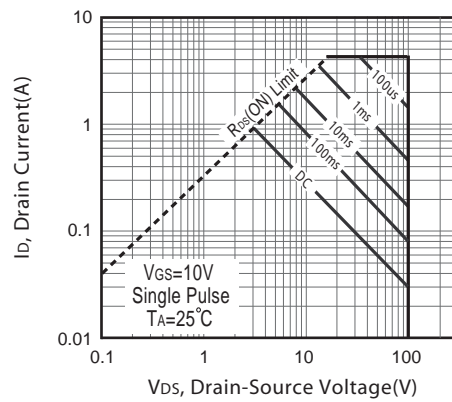
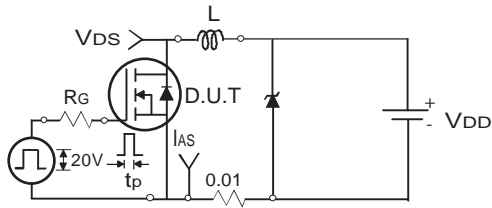
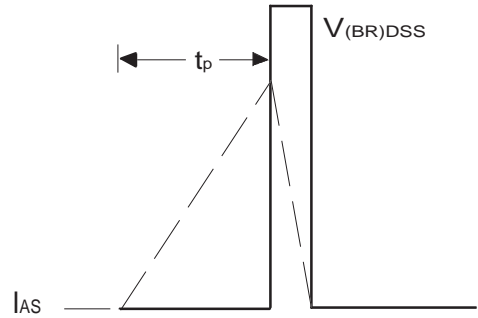

Figure 12. Maximum Safe Operating Area



Uncamped Inductive Test Circuit

Figure 13a.



Unclamped Inductive Waveforms

Figure 13b.

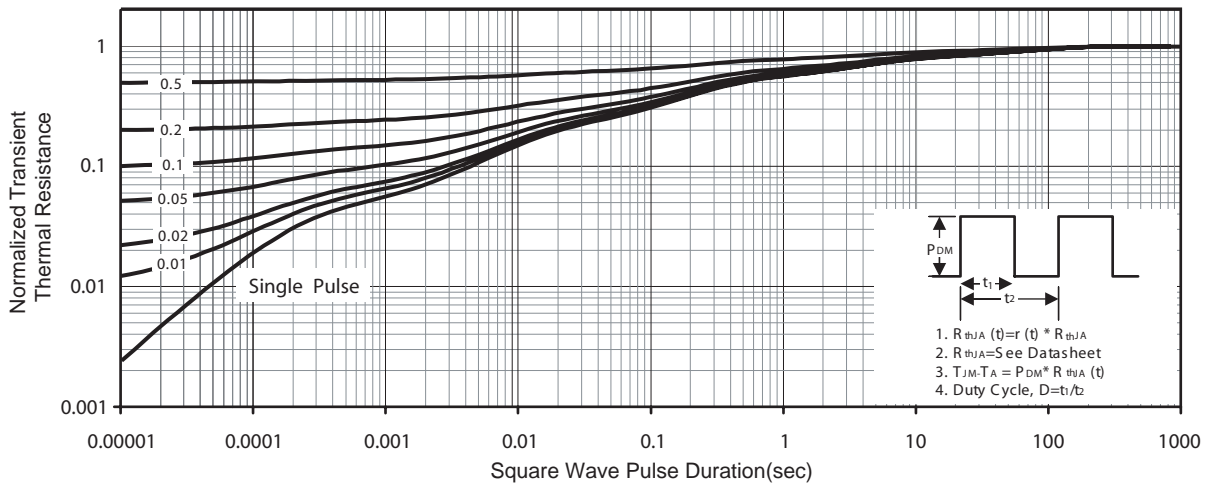
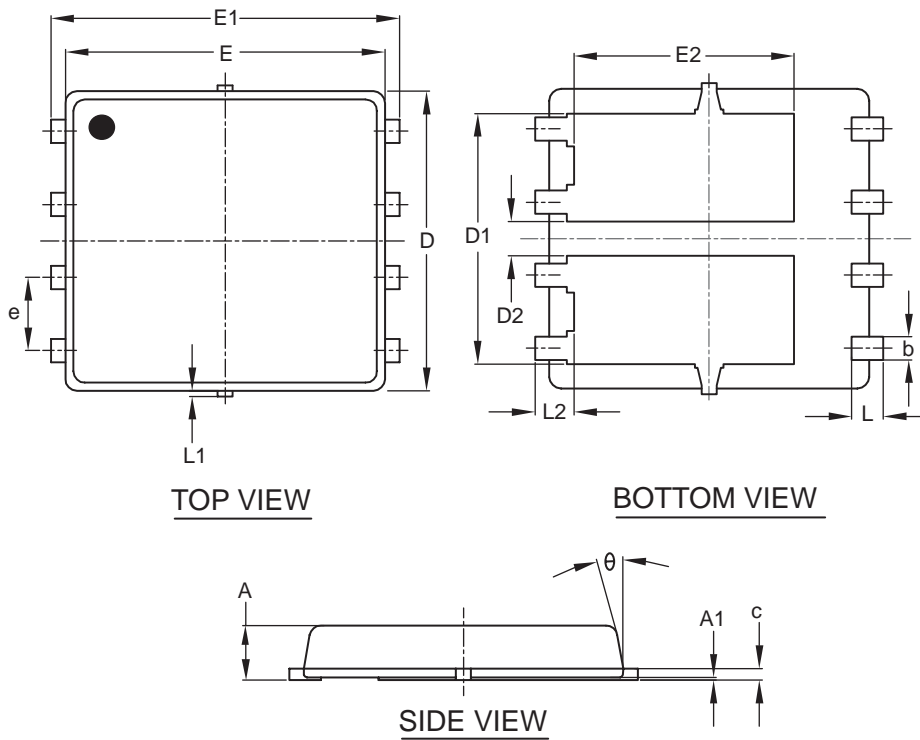

Figure 14. Normalized Thermal Transient Impedance Curve

## PACKAGE OUTLINE DIMENSIONS

### PDFN 5x6-8L



SYMBOLS	MILLIMETERS		
	MIN	NOM	MAX
A	0.85	0.95	1.00
A1	0.00	—	0.05
b	0.30	0.40	0.50
c	0.15	0.20	0.25
D	5.20 BSC		
D1	4.35 BSC		
D2	0.50	0.60	0.75
E	5.55 BSC		
E1	6.05 BSC		
E2	3.82 BSC		
e	1.27 BSC		
L	0.45	0.55	0.65
L1	0.00	—	0.15
L2	0.68 REF		
$\theta$	0°	—	10°

## TOP MARKING DEFINITION

